

**17W
4050**

Mitsubishi L200 DC/CC, Md. 2015

Side protection bar 76 mm

Flankenschutzrohr 76 mm

Protection latérale rondes (76 mm)

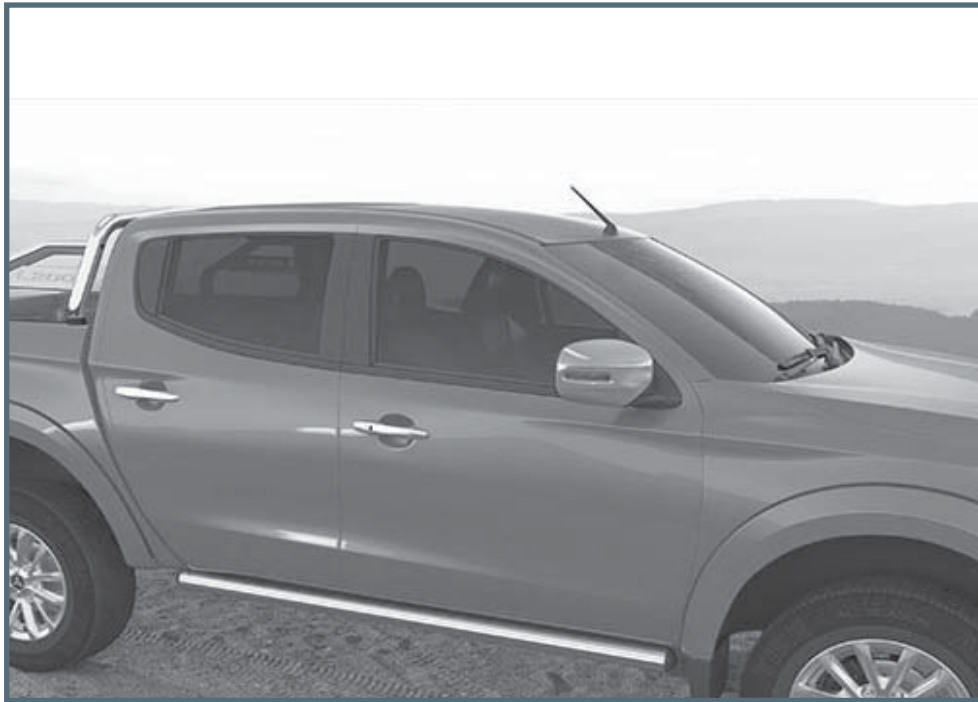

ASSEMBLY INSTRUCTION

Montageanleitung • Instructions de montage

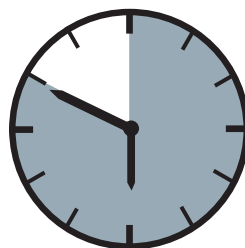

50 Minuten

Artikel-Nr:





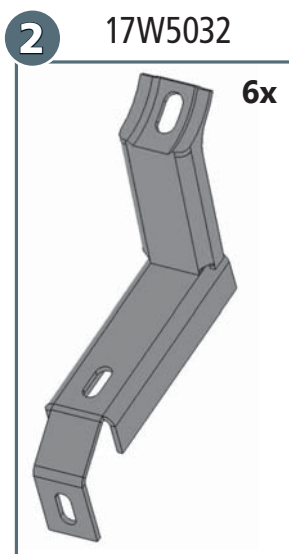
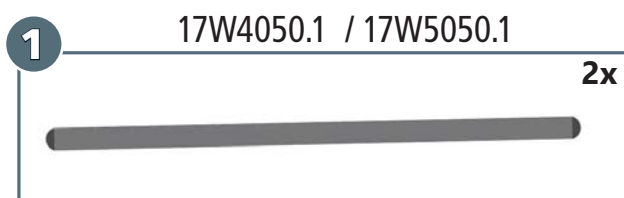
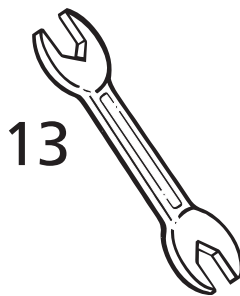
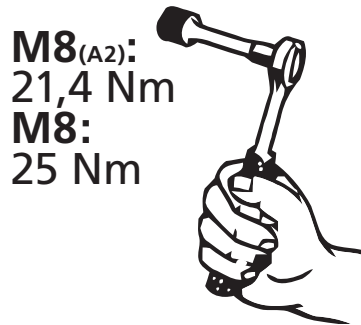

17W4050 stainless steel

17W5050 black steel

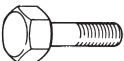
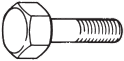
Revision 1: 09.11.2015





a		M8x20; DIN 933 Zn	6x
b		M8x25; DIN 933 A2	6x
c		M8; DIN 934 Zn	6x
d		Ø 8; DIN 127 Zn	12x
e		Ø 8; DIN 127 A2	6x
f		Ø 8,4; DIN 9021 Zn	12x
g		Ø 8,4; DIN 9021 A2	6x
h		SW 13	6x

Step 1

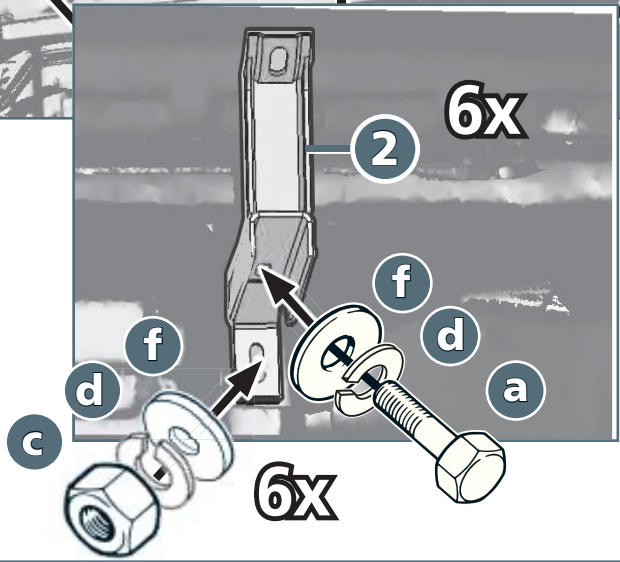
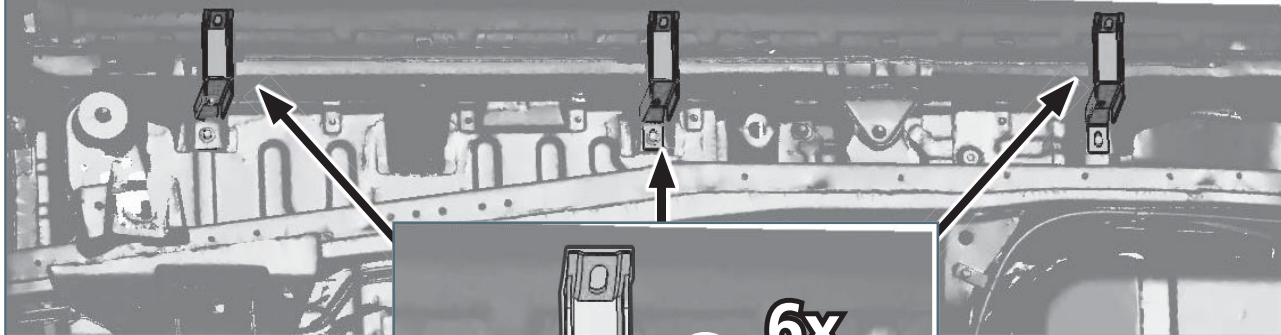
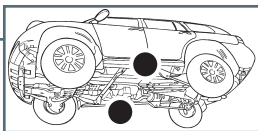

Step 2

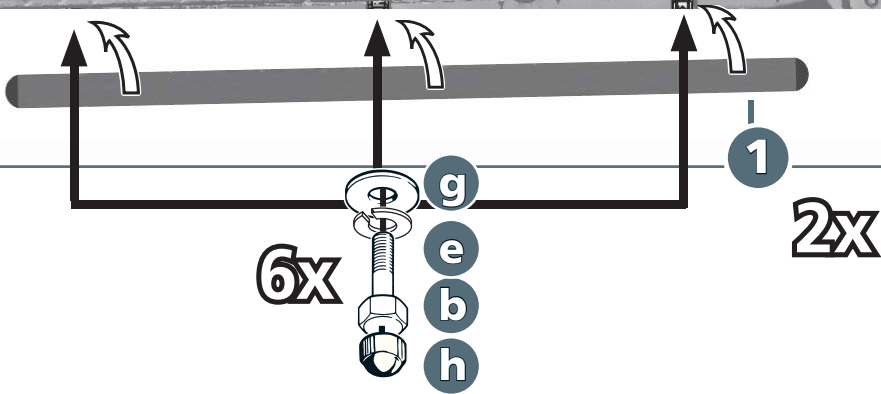

Step 3

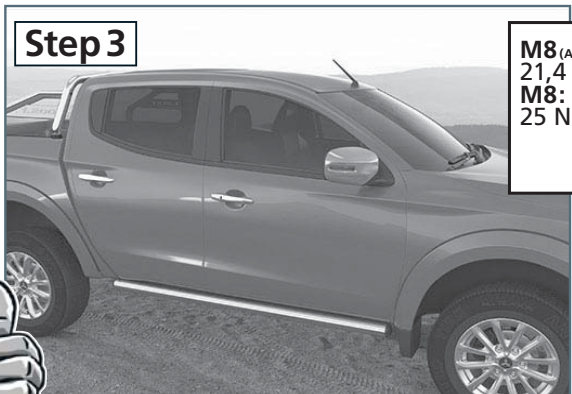

M8 (A2):
21,4 Nm
M8:
25 Nm



Revision 1: 09.11.2015