

**15U  
4113**

## **Isuzu D-Max; Md.2012+2017**

EU-pedestrian protection bar 76 mm with cross pipe 51 mm

EU-Personenschutzbügel 76 mm mit Querrohr 51 mm

Protection avant, homologuée CEE, 76 mm, traverse 51 mm

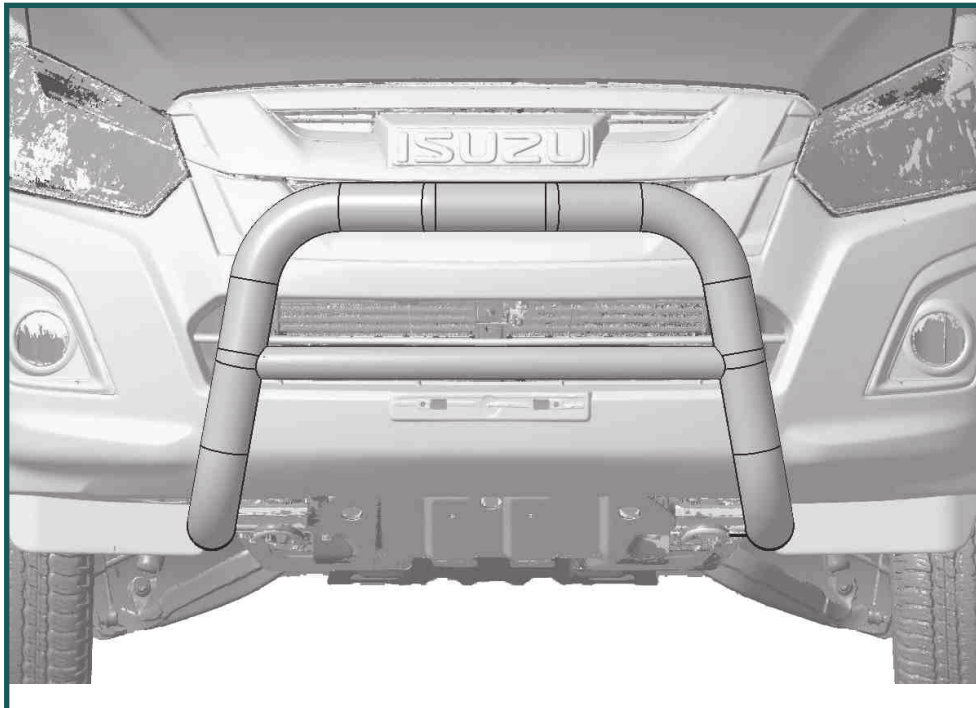

# **ASSEMBLY INSTRUCTION**

**Montageanleitung • Instructions de montage**



**45 Minuten**

**article no.:**

15U4113 (S) inox

15U5113 black steel

**Revision 7: 05.11.2018**



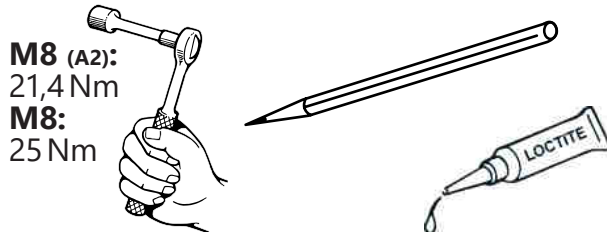
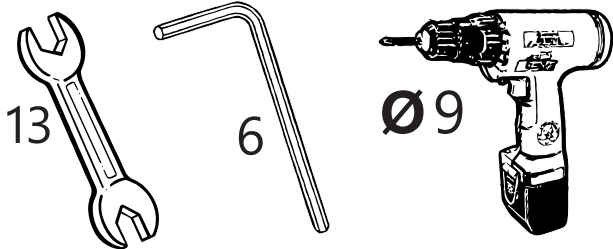

mounting kit: 15U9113

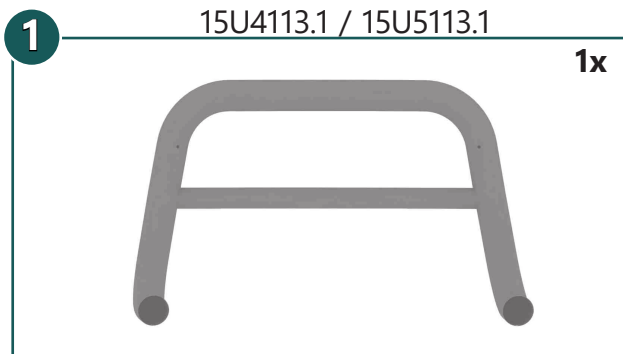

	M8 x 20; ähnl. ISO 7380 A2	<b>2x</b>
	M8 x 25; DIN 933 A2	<b>2x</b>
	M8 x 30; DIN 933 Zn	<b>2x</b>
	Ø 8,4; DIN 125 Zn	<b>2x</b>
	SW13	<b>2x</b>

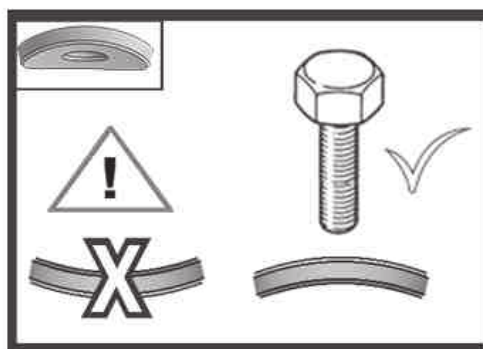
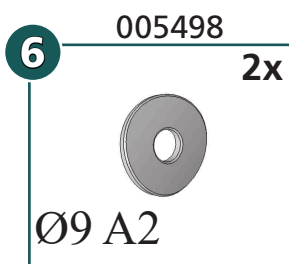
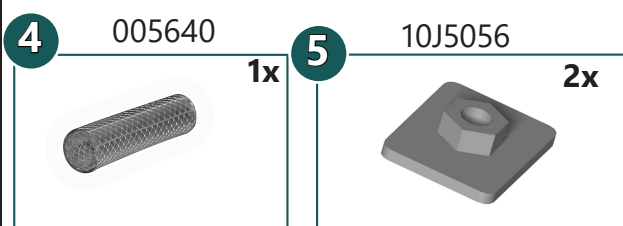
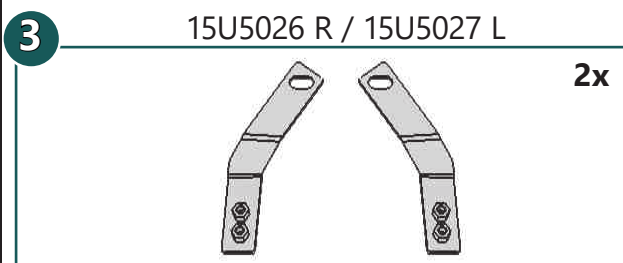
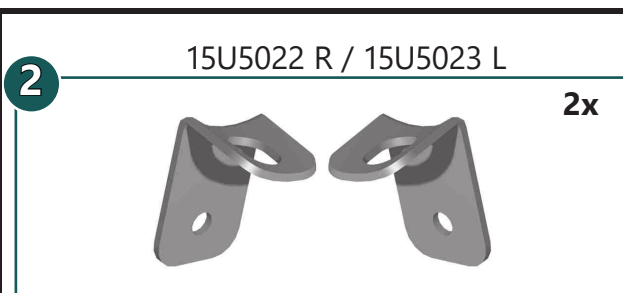

article no.:  
15U4113 (S) inox  
15U5113 black steel

Revision 7: 05.11.2018



