

17A 4111

Mercedes V-Klasse + Vito Md. 2024

EU-pedestrian protection bar 60 mm

EU-Personenschutzbügel 60 mm

Protection avant, homologuée CEE, 60 mm



*Compatible with CPA (Collision Prevention Assist)
Kompatibel mit Kollisionswarnsystem
compatible avec CPA

ASSEMBLY INSTRUCTION

Montageanleitung • Instructions de montage

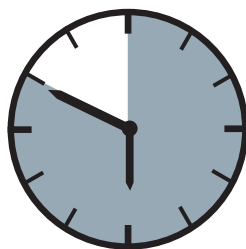

50 Minuten

article no.:

17A4111 (S) inox

17A5111 black steel

Revision 2: 15.10.2024



www.antec-online.de

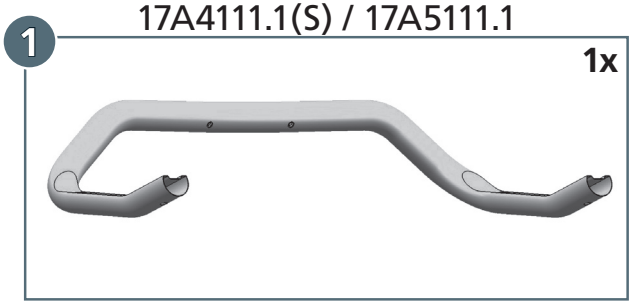
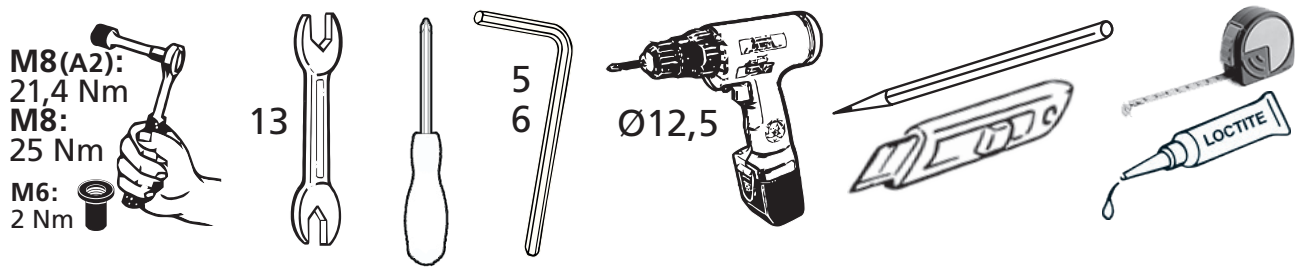

mounting kit: 17A9111N

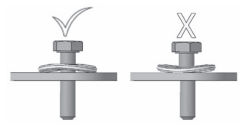
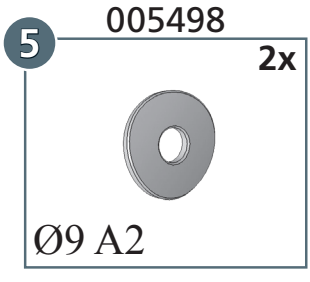
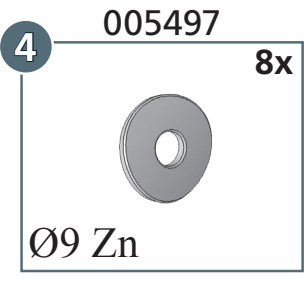
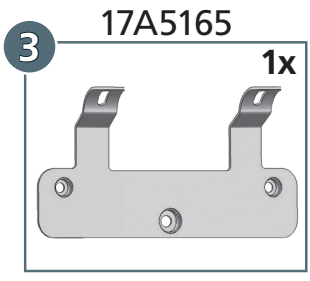
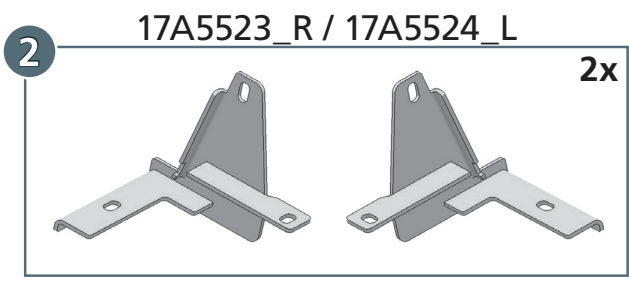

	M6x25; DIN 912 A2	3x
	M8x20; DIN 912 A2	2x
	M8x25; DIN 933 A2	2x
	M8x25; DIN 933 Zn	4x
	Ø4,8x19; DIN 7981 A2	4x
	M8; DIN 934 Zn	4x
	Ø5,3; DIN 9021 A2	4x
	Ø6,4; DIN 9021 A2	3x
	Ø8,4; DIN 9021 A2	2x
	Geto-Well M6	3x
	SW 13	2x

article no.:
 17A4111 (S) inox
 17A5111 black steel

Revision 2: 15.10.2024



